



**EUROPEAN NEW CAR ASSESSMENT PROGRAMME
(Euro NCAP)**



TEST PROTOCOL – AEB systems

Version 2.0.1
November 2017

Copyright 2018 ©Euro NCAP - This work is the intellectual property of Euro NCAP. Permission is granted for this material to be shared for non-commercial, educational purposes, provided that this copyright statement appears on the reproduced materials and notice is given that the copying is by permission of Euro NCAP. To disseminate otherwise or to republish requires written permission from Euro NCAP.

EUROPEAN NEW CAR ASSESSMENT PROGRAMME (Euro NCAP)

TEST PROTOCOL – AEB SYSTEMS

Table of Contents

1	INTRODUCTION	1
2	DEFINITIONS.....	2
3	REFERENCE SYSTEM.....	4
4	MEASURING EQUIPMENT.....	6
5	GLOBAL VEHICLE TARGET	8
6	MANUFACTURER DATA	9
7	TEST CONDITIONS	11
8	TEST PROCEDURE.....	15
ANNEX A	BRAKE APPLICATION PROCEDURE	20
A.1	Definitions	20
A.2	Measurements.....	20
A.3	Brake Characterization Procedure	20
A.3.1	Brake Displacement Characterisation Tests	20
A.3.2	Brake Force Confirmation and Iteration Procedure	21
A.4	Brake Application Profile	22

1 INTRODUCTION

Car-to-car rear impacts are one of the most frequent accidents happening on the roads due to driver distraction or misjudgement.

Typical accidents during city driving are normally occurring at relatively low speeds where the impacted car is already at standstill, but with a high risk of a debilitating whiplash injury to the driver of the struck vehicle. While injury severities are usually low, these accidents are very frequent and represent over a quarter of all crashes.

Similar accident scenarios occur on the open road, at moderate to higher speeds, where a driver might be distracted and may fail to recognise that the traffic in front of him is stopped, coming to a stop or is driving at a lower speed.

To support the driver in avoiding such nose to tail crashes, car manufactures offer avoidance technology that warns, supports adequate braking and/or ultimately stops the vehicle by itself. Systems that work mostly at lower speed are referred to as AEB City systems, those that function at higher speeds, AEB Inter-Urban systems.

This protocol specifies the AEB City and AEB Inter-Urban test procedures, which are part of the Adult Occupant Protection and the Safety Assist assessment, respectively. For AEB City, only the CCRs scenario is applicable where the AEB functionality at lower speed is tested. To be eligible to score points for AEB City, a good Whiplash score must be achieved for the front seat.

For AEB Inter-Urban, the system is tested in three scenarios (CCRs, CCRm and CCRb). For this type of AEB system, both the AEB and FCW functionality is assessed.

DEFINITIONS

Throughout this protocol the following terms are used:

Peak Braking Coefficient (PBC) – the measure of tyre to road surface friction based on the maximum deceleration of a rolling tyre, measured using the American Society for Testing and Materials (ASTM) E1136-10 (2010) standard reference test tyre, in accordance with ASTM Method E 1337-90 (reapproved 1996), at a speed of 64.4km/h, without water delivery.

Autonomous Emergency Braking (AEB) – braking that is applied automatically by the vehicle in response to the detection of a likely collision to reduce the vehicle speed and potentially avoid the collision.

Forward Collision Warning (FCW) – an audiovisual warning that is provided automatically by the vehicle in response to the detection of a likely collision to alert the driver.

Dynamic Brake Support (DBS) – a system that further amplifies the driver braking demand in response to the detection of a likely collision to achieve a greater deceleration than would otherwise be achieved for the braking demand in normal driving conditions.

Car-to-Car Rear Stationary (CCRs) – a collision in which a vehicle travels forwards towards another stationary vehicle and the frontal structure of the vehicle strikes the rear structure of the other.

Car-to-Car Rear Moving (CCRm) – a collision in which a vehicle travels forwards towards another vehicle that is travelling at constant speed and the frontal structure of the vehicle strikes the rear structure of the other.

Car-to-Car Rear Braking (CCRb) – a collision in which a vehicle travels forwards towards another vehicle that is travelling at constant speed and then decelerates, and the frontal structure of the vehicle strikes the rear structure of the other.

Vehicle under test (VUT) – means the vehicle tested according to this protocol with a pre-crash collision mitigation or avoidance system on board

Vehicle width – the widest point of the vehicle ignoring the rear-view mirrors, side marker lamps, tyre pressure indicators, direction indicator lamps, position lamps, flexible mud-guards and the deflected part of the tyre side-walls immediately above the point of contact with the ground.

Global Vehicle Target (GVT) – means the vehicle target used in this protocol

Time To Collision (TTC) – means the remaining time before the VUT strikes the GVT, assuming that the VUT and GVT would continue to travel with the speed it is travelling.

T_{AEB} – means the time where the AEB system activates. Activation time is determined by identifying the last data point where the filtered acceleration signal is below -1 m/s^2 , and then going back to the point in time where the acceleration first crossed -0.3 m/s^2

T_{FCW} – means the time where the audible warning of the FCW starts. The starting point is determined by audible recognition

V_{impact} – means the speed at which the VUT hits the GVT

V_{rel_impact} – means the relative speed at which the VUT hits the GVT by subtracting the velocity of the GVT from V_{impact} at the time of collision

3 REFERENCE SYSTEM

3.1 Convention

- 3.1.1 For both VUT and GVT use the convention specified in ISO 8855:1991 in which the x-axis points towards the front of the vehicle, the y-axis towards the left and the z-axis upwards (right hand system), with the origin at the most forward point on the centreline of the VUT for dynamic data measurements as shown in Figure 1.
- 3.1.2 Viewed from the origin, roll, pitch and yaw rotate clockwise around the x, y and z axes respectively. Longitudinal refers to the component of the measurement along the x-axis, lateral the component along the y-axis and vertical the component along the z-axis.
- 3.1.3 This reference system should be used for both left and right hand drive vehicles tested.

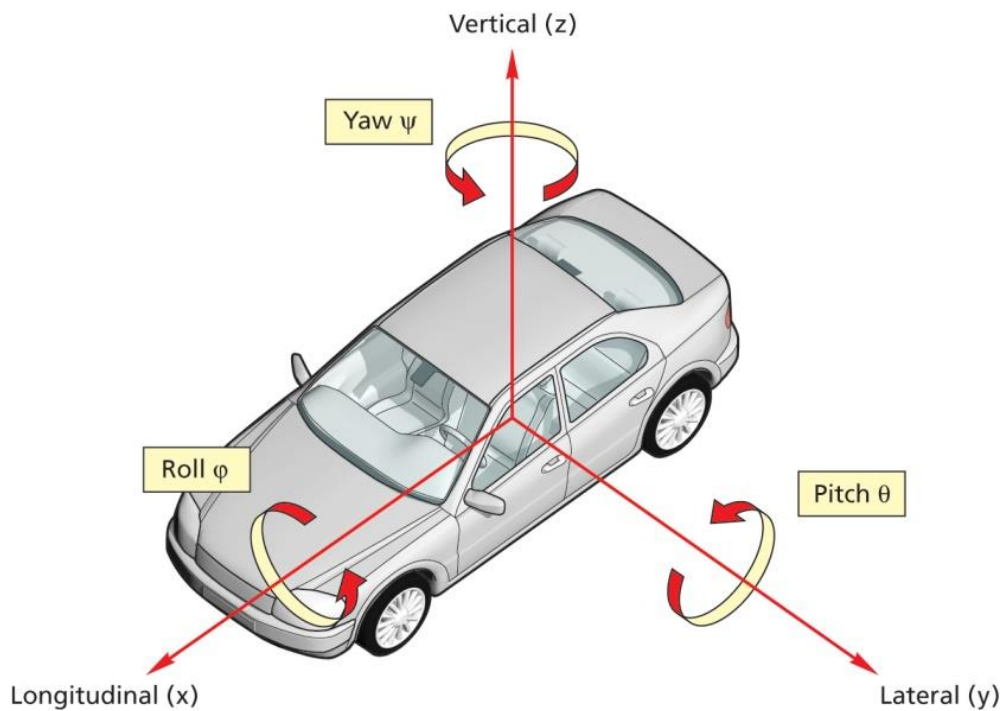

Figure 1: Coordinate system and notation

3.2 Lateral path error

3.2.1 The lateral path error is determined as the lateral distance between the centre of the front of the VUT and the centre of the rear of the GVT when measured in parallel to the intended straight lined path as shown in the figure below.

$$\text{Lateral path error} = Y_{\text{VUT error}} + Y_{\text{GVT error}}$$

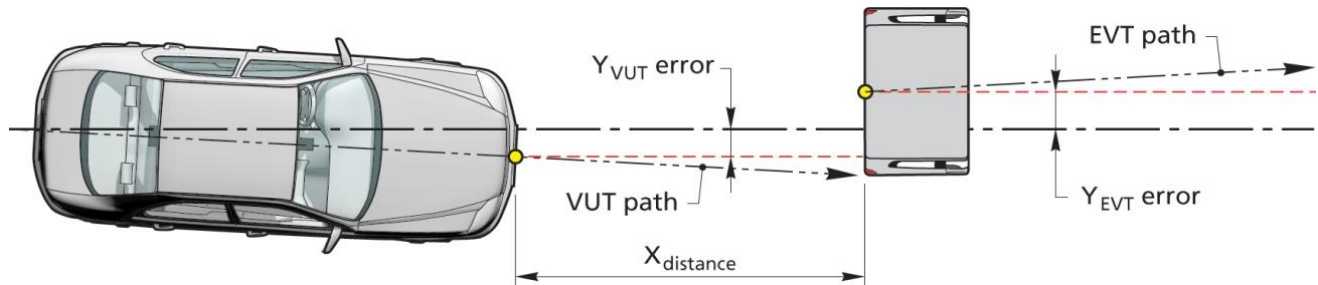

Figure 2: Lateral path error

3.3 Lateral overlap

3.3.1 The lateral overlap is defined as a percentage of the width of the VUT overlapping the GVT, where the reference line for the overlap definition is the centerline of the VUT. In case of 100% overlap, the centerlines of the VUT and GVT are aligned.

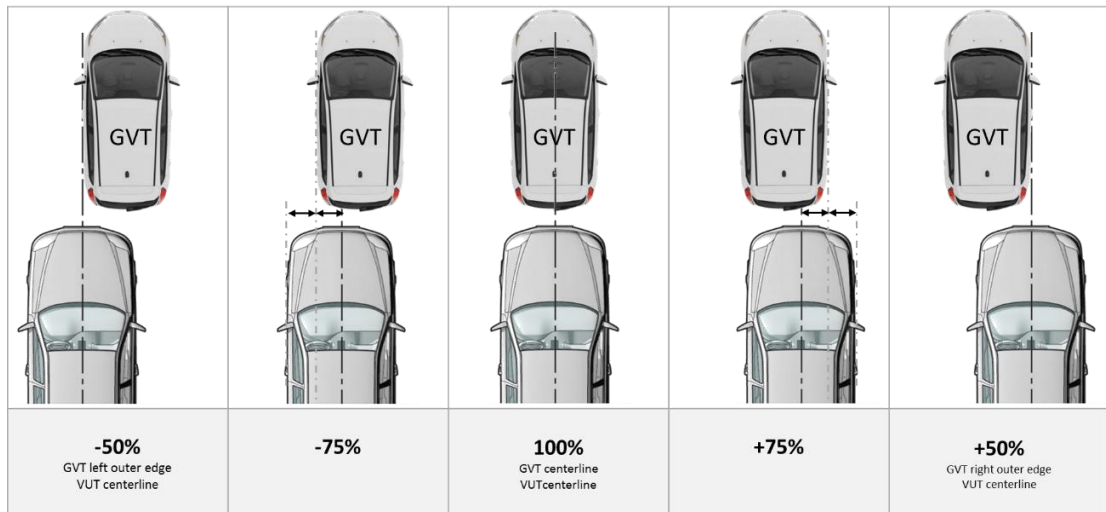

Figure 3: Lateral Overlap examples

4 MEASURING EQUIPMENT

4.1.1 Sample and record all dynamic data at a frequency of at least 100Hz. Synchronise using the DGPS time stamp the GVT data with that of the VUT.

4.2 Measurements and Variables

4.2.1	Time	T
	• CCRs and CCRm: T_0 equals $TTC = 4s$ (CCRb: T_0 when GVT starts decelerating)	T₀
	• T_{AEB} , time where AEB activates	T_{AEB}
	• T_{FCW} , time where FCW activates	T_{FCW}
	• T_{impact} , time where VUT impacts GVT	T_{impact}
4.2.2	Position of the VUT during the entire test	X_{VUT}, Y_{VUT}
4.2.3	Position of the GVT during the entire test	X_{GVT}, Y_{GVT}
4.2.4	Speed of the VUT during the entire test	V_{VUT}
	• V_{impact} , speed when VUT impacts GVT	V_{impact}
	• $V_{rel,impact}$, relative speed when VUT impacts GVT	V_{rel,impact}
4.2.5	Speed of the GVT during the entire test	V_{GVT}
4.2.6	Yaw velocity of the VUT during the entire test	ψ_{VUT}
4.2.7	Yaw velocity of the GVT during the entire test	ψ_{GVT}
4.2.8	Acceleration of the VUT during the entire test	A_{VUT}
4.2.9	Acceleration of the GVT during the entire test	A_{GVT}

4.3 Measuring Equipment

4.3.1 Equip the VUT and GVT with data measurement and acquisition equipment to sample and record data with an accuracy of at least:

- VUT and GVT speed to 0.1km/h;
- VUT and GVT lateral and longitudinal position to 0.03m;
- VUT and GVT yaw rate to 0.1°/s;
- VUT and GVT longitudinal acceleration to 0.1m/s²;
- VUT steering wheel velocity to 1.0 °/s.

4.4 Data Filtering

4.4.1 Filter the measured data as follows:

4.4.1.1 Position and speed are not filtered and are used in their raw state.

4.4.1.2 Acceleration, yaw rate, steering wheel velocity and force are filtered with a 12-pole phaseless Butterworth filter with a cut off frequency of 10Hz.

5 GLOBAL VEHICLE TARGET

5.1 Specification

5.1.1 Conduct the tests in this protocol using the Global Vehicle Target (GVT) as shown in Figure 3 below. The GVT replicates the visual, radar and LIDAR attributes of a typical M₁ passenger vehicle.



Figure 3: Global Vehicle Target (GVT)

5.1.2 The GVT is designed to work with the following types of sensors:

- Radar (24 and 77 GHz)
- LIDAR
- Camera

When a manufacturer believes that the GVT is not suitable for another type of sensor system used by the VUT but not listed above, the manufacturer is asked to contact the Euro NCAP Secretariat.

6 MANUFACTURER DATA

6.1 Manufacturer Supplied Data

6.1.1 The vehicle manufacturer is required to provide the Euro NCAP Secretariat with colour data (expected impact speeds are not required) detailing the performance of the vehicle in the CCRs and CCRm scenarios for all overlap and impact speed combinations. The prediction is to be done for both AEB and FCW system tests where applicable.

6.1.2 All data must be supplied by the manufacturer before any testing begins, preferably with delivery of the test vehicle(s).

6.1.3 Data shall be provided for each grid point according to the following colour scheme for AEB City (CCRs 10-50km/h) and for AEB Inter-Urban (CCRs 30-80km/h & CCRm 30-80km/h):

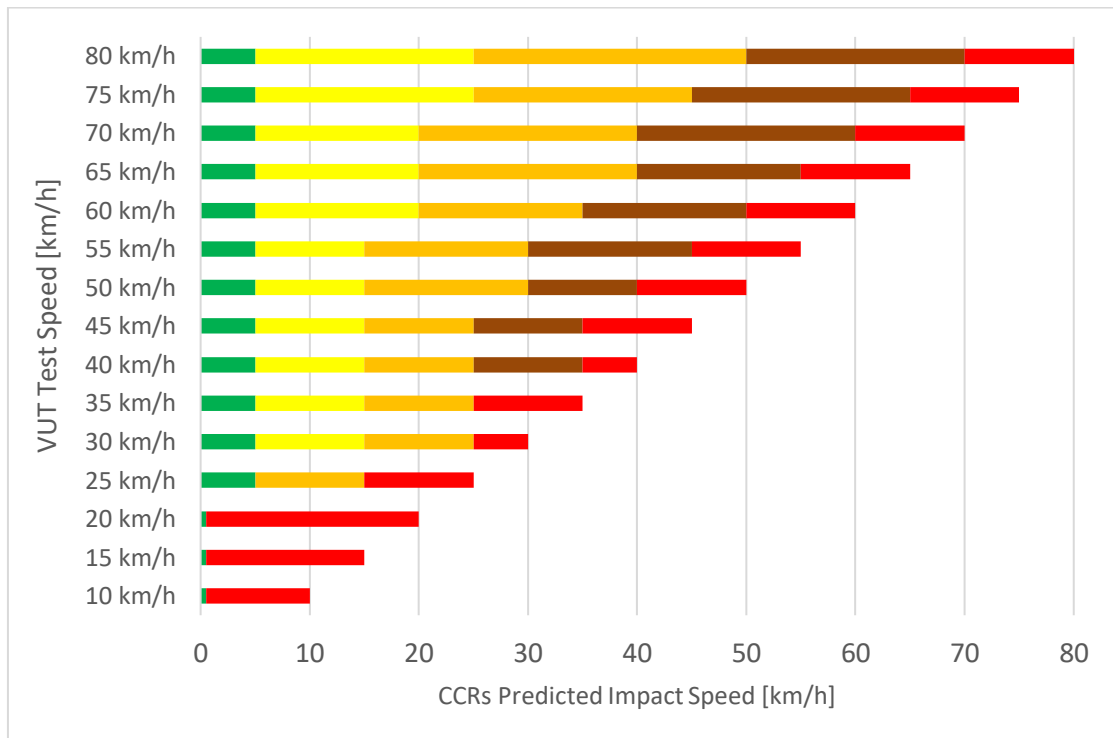

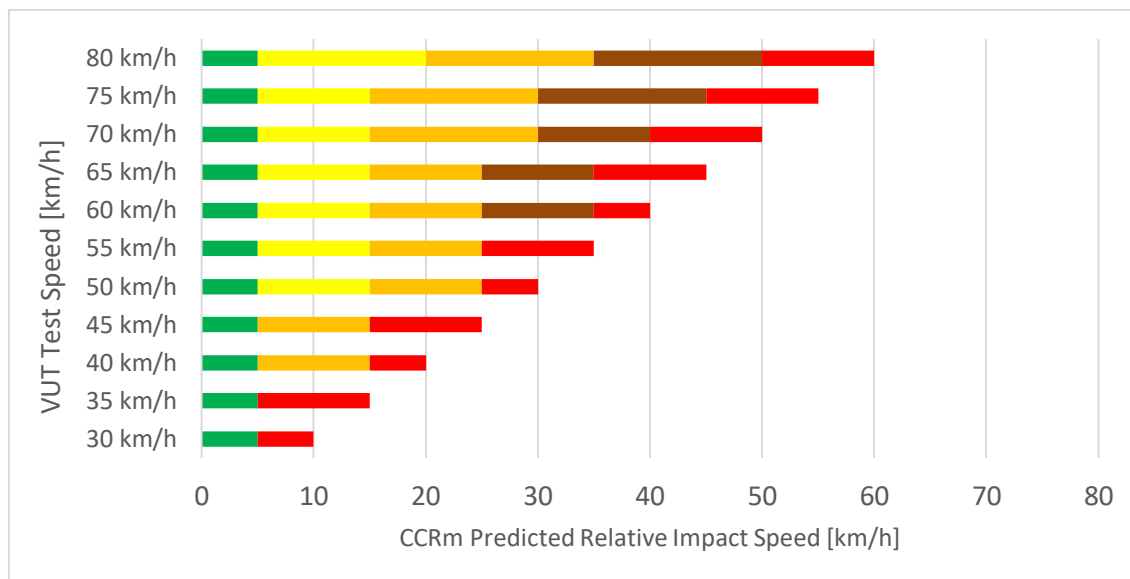

6.2 Absence of Manufacturer Data

6.2.1 Where predicted data is NOT provided by the vehicle manufacturer, ALL grid points are to be tested by the Euro NCAP laboratory, taking into account symmetry.

6.2.2 A system can consist of a combined AEB and FCW function or separate AEB or FCW functions. For combined systems, both sections 6.2.2.1 and 6.2.2.2 apply. Where the functions are separate, section 6.2.2.1 applies to the AEB function and 6.2.2.2 applies to the FCW.

6.2.2.1 For AEB systems tests, when there is complete avoidance, the subsequent test speed for the next test is incremented with 10km/h. When there is contact, first perform a test at a test speed 5km/h less than the test speed where contact occurred. After this test continue to perform the remainder of the tests with speed increments of 5km/h by repeating section 8.3.1 to 8.4.3. Stop testing when the speed reduction seen in the test is less than 5 km/h.

6.2.2.2 For FCW system tests, when there is complete avoidance, the subsequent test speed for the next test is incremented by 10km/h. When there is contact, first perform a test at a test speed 5km/h less than the test speed where contact occurred. After this test continue to perform the remainder of the tests with speed increments of 5km/h by repeating section 8.3.1 to 8.4.3. In the AEB Inter-Urban CCRm and CCRb scenarios, only perform tests at the test speeds where there was no avoidance in the AEB function tests, where applicable. Stop testing when the speed reduction seen in the test is less than 5 km/h or the relative impact speed is more than 50 km/h.

7 TEST CONDITIONS

7.1 Test Track

- 7.1.1 Conduct tests on a dry (no visible moisture on the surface), uniform, solid-paved surface with a consistent slope between level and 1%. The test surface shall have a minimal peak braking coefficient (PBC) of 0.9.
- 7.1.2 The surface must be paved and may not contain any irregularities (e.g. large dips or cracks, manhole covers or reflective studs) that may give rise to abnormal sensor measurements within a lateral distance of 3.0m to either side of the test path and with a longitudinal distance of 30m ahead of the VUT when the test ends.
- 7.1.3 The presence of lane markings is allowed. However, testing may only be conducted in an area where typical road markings depicting a driving lane may not be parallel to the test path within 3.0m either side. Lines or markings may cross the test path, but may not be present in the area where AEB activation and/or braking after FCW is expected.

7.2 Weather Conditions

- 7.2.1 Conduct tests in dry conditions with ambient temperature above 5°C and below 40°C.
- 7.2.2 No precipitation shall be falling and horizontal visibility at ground level shall be greater than 1km. Wind speeds shall be below 10m/s to minimise GVT and VUT disturbance.
- 7.2.3 Natural ambient illumination must be homogenous in the test area and in excess of 2000 lux for daylight testing with no strong shadows cast across the test area other than those caused by the VUT or GVT. Ensure testing is not performed driving towards, or away from the sun when there is direct sunlight.
- 7.2.4 Measure and record the following parameters preferably at the commencement of every single test or at least every 30 minutes:
 - a) Ambient temperature in °C;
 - b) Track Temperature in °C;
 - c) Wind speed and direction in m/s;
 - d) Ambient illumination in Lux.

7.3 Surroundings

- 7.3.1 Conduct testing such that there are no other vehicles, highway furniture, obstructions, other objects or persons protruding above the test surface that may give rise to abnormal sensor measurements within a lateral distance of 3.0m to either side of the test path and within a longitudinal distance of 30m ahead of the VUT when the test ends (Figure 4).

7.3.2 Test areas where the VUT needs to pass under overhead signs, bridges, gantries or other significant structures are not permitted.

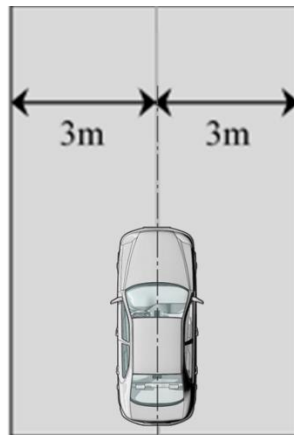

Figure 4: Free surroundings

7.3.3 The general view ahead and to either side of the test area shall comprise of a wholly plain man made or natural environment (e.g. further test surface, plain coloured fencing or hoardings, natural vegetation or sky etc.) and must not comprise any highly reflective surfaces or contain any vehicle-like silhouettes that may give rise to abnormal sensor measurements.

7.4 VUT Preparation

7.4.1 AEB and FCW System Settings

7.4.1.1 Set any driver configurable elements of the AEB and/or FCW system (e.g. the timing of the collision warning or the braking application if present) to the middle setting or midpoint and then next latest setting similar to the examples shown in Figure 5.

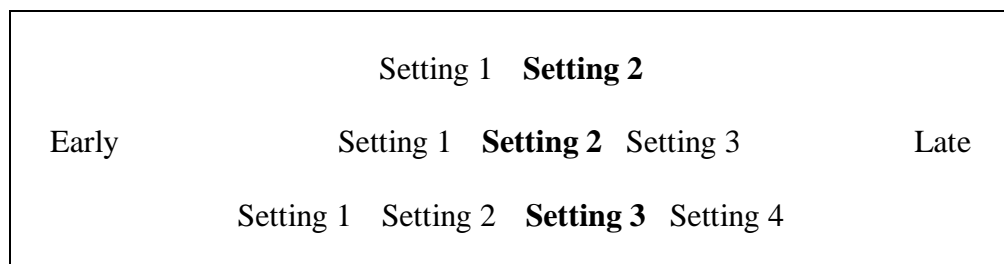

Figure 5: AEB and/or FCW system setting for testing

7.4.2 Deployable Pedestrian/VRU Protection Systems

When the vehicle is equipped with a deployable pedestrian/VRU protection system, this system shall be deactivated before the testing commences.

7.4.3 Tyres

Perform the testing with new original fitment tyres of the make, model, size, speed and load rating as specified by the vehicle manufacturer. It is permitted to change the tyres which are supplied by the manufacturer or acquired at an official dealer representing the manufacturer if those tyres are identical make, model, size, speed and load rating to the original fitment. Inflate the tyres to the vehicle manufacturer's recommended cold tyre inflation pressure(s). Use inflation pressures corresponding to least loading normal condition.

Run-in tyres according to the tyre conditioning procedure specified in 8.1.2. After running-in maintain the run-in tyres in the same position on the vehicle for the duration of the testing.

7.4.4 Wheel Alignment Measurement

The vehicle should be subject to a vehicle (in-line) geometry check to record the wheel alignment set by the OEM. This should be done with the vehicle in kerb weight.

7.4.5 Unladen Kerb Mass

7.4.5.1 Fill up the tank with fuel to at least 90% of the tank's capacity of fuel.

7.4.5.2 Check the oil level and top up to its maximum level if necessary. Similarly, top up the levels of all other fluids to their maximum levels if necessary.

7.4.5.3 Ensure that the vehicle has its spare wheel on board, if fitted, along with any tools supplied with the vehicle. Nothing else should be in the car.

7.4.5.4 Ensure that all tyres are inflated according to the manufacturer's instructions for the appropriate loading condition.

7.4.5.5 Measure the front and rear axle masses and determine the total mass of the vehicle. The total mass is the 'unladen kerb mass' of the vehicle. Record this mass in the test details.

7.4.5.6 Calculate the required ballast mass, by subtracting the mass of the test driver and test equipment from the required 200 kg interior load.

7.4.6 Vehicle Preparation

7.4.6.1 Fit the on-board test equipment and instrumentation in the vehicle. Also fit any associated cables, cabling boxes and power sources.

7.4.6.2 Place weights with a mass of the ballast mass. Any items added should be securely attached to the car.

7.4.6.3 With the driver in the vehicle, weigh the front and rear axle loads of the vehicle.

7.4.6.4 Compare these loads with the "unladen kerb mass"

- 7.4.6.5 The total vehicle mass shall be within $\pm 1\%$ of the sum of the unladen kerb mass, plus 200kg. The front/rear axle load distribution needs to be within 5% of the front/rear axle load distribution of the original unladen kerb mass plus full fuel load. If the vehicle differs from the requirements given in this paragraph, items may be removed or added to the vehicle which has no influence on its performance. Any items added to increase the vehicle mass should be securely attached to the car.
- 7.4.6.6 Repeat paragraphs 7.4.6.3 and 7.4.6.4 until the front and rear axle loads and the total vehicle mass are within the limits set in paragraph 7.4.6.5. Care needs to be taken when adding or removing weight in order to approximate the original vehicle inertial properties as close as possible. Record the final axle loads in the test details. Record the axle weights of the VUT in the 'as tested' condition.

8 TEST PROCEDURE

8.1 VUT Pre-test Conditioning

8.1.1 General

8.1.1.1 A new car is used as delivered to the test laboratory.

8.1.1.2 If requested by the vehicle manufacturer, drive a maximum of 100km on a mixture of urban and rural roads with other traffic and roadside furniture to ‘calibrate’ the sensor system. Avoid harsh acceleration and braking.

8.1.2 Brakes

8.1.2.1 Condition the vehicle’s brakes in the following manner, if it has not been done before or in case the lab has not performed a 100km of driving:

- Perform twenty stops from a speed of 56km/h with an average deceleration of approximately 0.5 to 0.6g.
- Immediately following the series of 56km/h stops, perform three additional stops from a speed of 72km/h, each time applying sufficient force to the pedal to operate the vehicle’s antilock braking system (ABS) for the majority of each stop.
- Immediately following the series of 72km/h stops, drive the vehicle at a speed of approximately 72km/h for five minutes to cool the brakes.

8.1.3 Tyres

8.1.3.1 Condition the vehicle’s tyres in the following manner to remove the mould sheen, if this has not been done before for another test or in case the lab has not performed a 100km of driving:

- Drive around a circle of 30m in diameter at a speed sufficient to generate a lateral acceleration of approximately 0.5 to 0.6g for three clockwise laps followed by three anticlockwise laps.
- Immediately following the circular driving, drive four passes at 56km/h, performing ten cycles of a sinusoidal steering input in each pass at a frequency of 1Hz and amplitude sufficient to generate a peak lateral acceleration of approximately 0.5 to 0.6g.
- Make the steering wheel amplitude of the final cycle of the final pass double that of the previous inputs.

8.1.3.2 In case of instability in the sinusoidal driving, reduce the amplitude of the steering input to an appropriately safe level and continue the four passes.

8.1.4 AEB/FCW System Check

- 8.1.4.1 Before any testing begins, perform a maximum of ten runs at the lowest test speed the system is supposed to work, to ensure proper functioning of the system.

8.2 Test Scenarios

- 8.2.1 The performance of the AEB system is assessed in the CCRs, CCRm and CCRb scenarios as shown in Figures 6abc.

The assessment is based on a GRID prediction provided by the OEM. The actual scenarios to be tested to verify the prediction will be chosen randomly, distributed in line with the predicted colour distribution (excluding red points).

The vehicle sponsor will fund 10 verification tests per scenario, where applicable. For AEB City, 10 tests in CCRs (10-50km/h). For AEB Inter-Urban, 10 tests for AEB (CCRm) and 10 tests for FCW (CCRs and CCRm).

The vehicle manufacturer has the option of sponsoring up to 10 additional verification tests for AEB City and 10 for AEB Inter-Urban.

- 8.2.2 For testing purposes, assume a straight line path equivalent to the centreline of the lane in which the collision occurred, hereby known as the test path. Control the VUT with driver inputs or using alternative control systems that can modulate the vehicle controls as necessary to perform the tests.

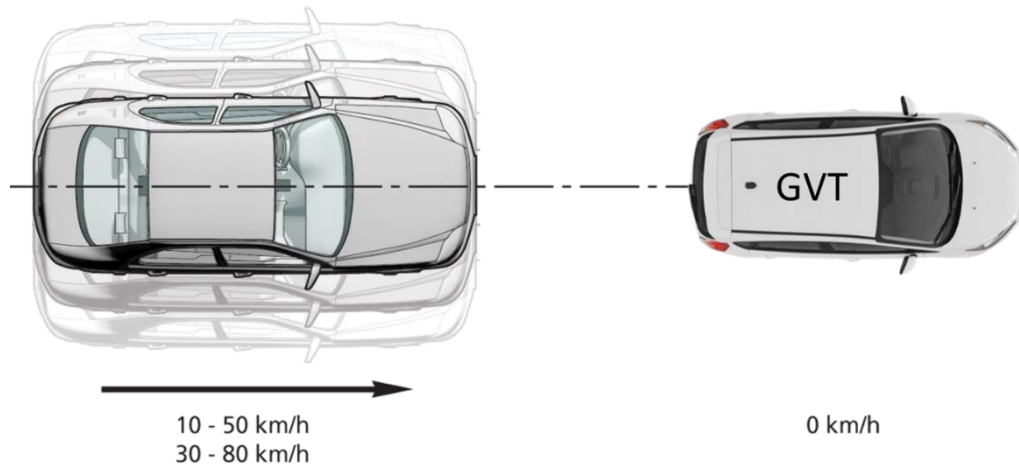

Figure 6a: CCRs scenario

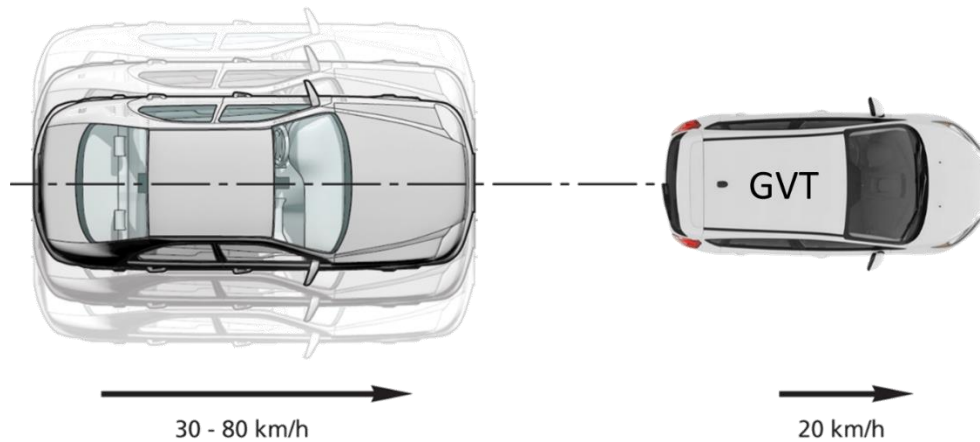

Figure 6b: CCRm scenario

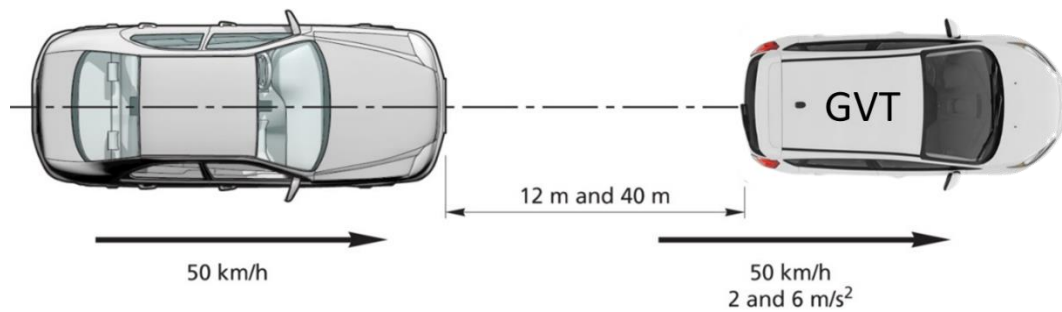

Figure 6c: CCRb scenario

8.2.3 The CCRs and CCRm scenarios are a combination of speed and overlap with 5km/h incremental steps in speed and 25% in overlap within the ranges as shown in the tables below.

	CCRs			
	AEB + FCW combined		AEB only	FCW only
	AEB	FCW		
AEB City	10-50 km/h -50%-50%	-	10-50 km/h -50%-50%	-
AEB Inter-Urban	-	30-80 km/h -50%-50%	30-80 km/h -50%-50%	30-80 km/h -50%-50%

	CCRm			
	AEB + FCW combined		AEB only	FCW only
	AEB	FCW		
AEB Inter-Urban	30-80 km/h -50%-50%	50-80 km/h -50%-50%	30-80 km/h -50%-50%	50-80 km/h -50%-50%

The CCRb tests will be performed at a fixed speed of 50km/h for both VUT and GVT with all combinations of 2 and 6m/s² deceleration and 12 and 40m headway. Different overlap situations may be tested for monitoring purpose at the end of the test program.

	CCRb		
	AEB+FCW combined, AEB only & FCW only		
		2 m/s ²	6 m/s ²
AEB Inter-Urban	12m	50 km/h	50 km/h
	40m	50 km/h	50 km/h

- 8.2.4.1 The desired deceleration of the GVT shall be reached within 1.0 seconds (T₀ + 1.0s) which after the GVT shall remain within ± 0.5 km/h of the reference speed profile, derived from the desired deceleration, until the vehicle speed equals 1 km/h.

8.3 Test Conduct

- 8.3.1 Before every test run, drive the VUT around a circle of maximum diameter 30m at a speed less than 10km/h for one clockwise lap followed by one anticlockwise lap, and then manoeuvre the VUT into position on the test path. If requested by the OEM an initialisation run may be included before every test run. Bring the VUT to a halt and push the brake pedal through the full extent of travel and release.
- 8.3.2 For vehicles with an automatic transmission select D. For vehicles with a manual transmission select the highest gear where the RPM will be at least 1500 at the test speed. If fitted, a speed limiting device or cruise control may be used to maintain the VUT speed (not ACC), unless the vehicle manufacturer shows that there are interferences of these devices with the AEB system in the VUT. Apply only minor steering inputs as necessary to maintain the VUT tracking along the test path.
- 8.3.3 Perform the first test a minimum of 90s and a maximum of 10 minutes after completing the tyre conditioning (if applicable), and subsequent tests after the same time period. If the time between consecutive tests exceeds 10 minutes perform three brake stops from 72 km/h at approximately 0.3g.

Between tests, manoeuvre the VUT at a maximum speed of 50km/h and avoid riding the brake pedal and harsh acceleration, braking or turning unless strictly necessary to maintain a safe testing environment.

8.4 Test Execution

8.4.1 Accelerate the VUT and GVT (if applicable) to the respective test speeds.

8.4.2 The test shall start at T_0 (4s TTC) and is valid when all boundary conditions are met between T_0 and T_{AEB} and/or T_{FCW} , or any other system intervention:

- Speed of VUT (GPS-speed)	Test speed + 1.0 km/h
- Speed of GVT (GPS-speed)	Test speed \pm 1.0 km/h
- Lateral deviation from test path for VUT	0 ± 0.05 m
- Lateral deviation from test path for GVT	$0 \pm [0.10]$ m
- Relative distance VUT and GVT (CCRb)	12m or 40m \pm 0.5m
- Yaw velocity of VUT	0 ± 1.0 °/s
- Yaw velocity of GVT	$0 \pm [1.0]$ °/s
- Steering wheel velocity	0 ± 15.0 °/s

8.4.3 The end of a test is considered when one of the following occurs:

- $V_{VUT} = 0$ km/h
- $V_{VUT} < V_{GVT}$
- Contact between VUT and GVT

8.4.3.1 For manual or automatic accelerator control, it needs to be assured that during automatic brake the accelerator pedal does not result in an override of the system.

8.4.3.2 The FCW system tests should be performed using a braking robot reacting to the warning with a delay time of 1.2 seconds as per A.4 to account for driver reaction time.

8.4.3.3 Braking will be applied that results in a maximum brake level of $-4 \text{ m/s}^2 - 0.25 \text{ m/s}^2$ when applied in a non-threat situation. The particular brake profile to be applied (pedal application rate applied in 200ms (max. 400mm/s) and pedal force) shall be specified by the manufacturer. When the brake profile provided by the manufacturer results in a higher brake level than allowed, the iteration steps as described in ANNEX B will be applied to scale the brake level to $-4 \text{ m/s}^2 - 0.25 \text{ m/s}^2$.

8.4.3.4 When no brake profile is provided, the default brake profile as described in ANNEX A will be applied.

ANNEX A BRAKE APPLICATION PROCEDURE

The braking input characterisation test determines the brake pedal displacement and force necessary to achieve a vehicle deceleration typical of that produced by a typical real world driver in emergency situations.

A.1 Definitions

T_{BRAKE} - The point in time where the brake pedal displacement exceeds 5mm.

T_{-6m/s²} - The point in time is defined as the first data point where filtered, zeroed and corrected longitudinal acceleration data is less than -6m/s^2 .

T_{-2m/s²}, T_{-4m/s²} - similar to T_{-6m/s²}.

A.2 Measurements

Measurements and filters to be applied as described in Chapter 4 of this protocol.

A.3 Brake Characterization Procedure

First perform the brake and tyre conditioning tests as described in 8.1.2 and 8.1.3. The brake input characterisation tests shall be undertaken within 10 minutes after conditioning the brakes and tyres.

A.3.1 Brake Displacement Characterisation Tests

- Push the brake pedal through the full extent of travel and release.
- Accelerate the VUT to a speed in excess of 85km/h. Vehicles with an automatic transmission will be driven in D. For vehicles with a manual transmission select the highest gear where the RPM will be at least 1500 at the 85km/h.
- Release the accelerator and allow the vehicle to coast. At a speed of $80 \pm 1.0\text{km/h}$ initiate a ramp braking input with a pedal application rate of $20 \pm 5\text{mm/s}$ and apply the brake until a longitudinal acceleration of -7m/s^2 is achieved. For manual transmission vehicles, press the clutch as soon as the RPM drops below 1500. The test ends when a longitudinal acceleration of -7m/s^2 is achieved.
- Measure the pedal displacement and applied force normal to the direction of travel of the initial stroke of the brake pedal, or as close as possible to normal as can be repeatedly achieved.

8.4.4 Perform three consecutive test runs. A minimum time of 90 seconds and a maximum time of 10 minutes shall be allowed between consecutive tests. If the maximum time of 10 minutes is exceeded, perform three brake stops from 72 km/h at approximately 0.3g.

- Using second order curve fit and the least squares method between T_{-2m/s^2} , T_{-6m/s^2} , calculate the pedal travel value corresponding to a longitudinal acceleration of $-4 m/s^2$ (=D4, unit is m). Use data of at least three valid test runs for the curve fitting.
- This brake pedal displacement is referred to as D4 in the next chapters.
- Using second order curve fit and the least squares method between T_{-2m/s^2} , T_{-6m/s^2} , calculate the pedal force value corresponding to a longitudinal acceleration of $-4 m/s^2$ (=F4, unit is N). Use data of at least three valid test runs for the curve fitting.
- This brake pedal force is referred to as F4 in the next chapters.

A.3.2 Brake Force Confirmation and Iteration Procedure

- Accelerate the VUT to a speed of 80+1km/h. Vehicles with an automatic transmission will be driven in D. For vehicles with a manual transmission select the highest gear where the RPM will be at least 1500 at the 80km/h.
- Apply the brake force profile as specified in B.4, triggering the input manually rather than in response to the FCW. Determine the mean acceleration achieved during the window from $T_{BRAKE} + 1s$ $T_{BRAKE} + 3s$. If a mean acceleration outside the range of $-4-0.5m/s^2$ results, apply the following method to ratio the pedal force applied.

$F4_{new} = F4_{original} * (-4/mean\ acceleration)$, i.e. if $F4_{original}$ results in a mean acceleration of $-5m/s^2$, $F4_{new} = F4_{original} * -4 / -5$

- Repeat the brake force profile with this newly calculated F4, determine the mean acceleration achieved and repeat the method as necessary until a mean acceleration within the range of $-4-0.5m/s^2$ is achieved.

8.4.5 Three valid pedal force characteristic tests (with the acceleration level being in the range as specified) are required. A minimum time of 90 seconds and a maximum time of 10 minutes shall be allowed between consecutive tests. If the maximum time of 10 minutes is exceeded, perform three brake stops from 72 km/h at approximately 0.3g.

- before restarting the brake pedal force characterisation tests. This brake pedal force is referred as F4 in the next chapters.

A.4 Brake Application Profile

- Detect TFCW during the experiment in real-time.
- Release the accelerator at $T_{FCW} + 1$ s.
- Perform displacement control for the brake pedal, starting at $T_{FCW} + 1.2$ s with a gradient of the lesser of $5 \times D4$ or 400mm/s (meaning the gradient to reach pedal position D4 within 200ms, but capped to a maximum application rate of 400mm/s).
- Monitor brake force during displacement control and use second-order filtering with a cut-off frequency between 20 and 100 Hz (online) as appropriate.
- Switch to force control, maintaining the force level, with a desired value of F4 when
 - i. the value D4 as defined in B.3 is exceeded for the first time,
 - ii. the force F4 as defined in B.3 is exceeded for the first time,whichever is reached first.
- The point in time where position control is switched to force control is noted as T_{switch} .
- Maintain the force within boundaries of $F4 \pm 25\% F4$. A stable force level should be achieved within a period of 200 ms maximum after the start of force control. Additional disturbances of the force over $\pm 25\% F4$ due to further AEB interventions are allowed, as long as they have a duration of less than 200ms.
- The average value of the force between $T_{FCW} + 1.4$ s and the end of the test should be in the range of $F4 \pm 10$ N.